

* Check cabinet datasheet before applying power

Project title:	FeedMixer V1.X.X	Project no.:	FeedMixer	Project rev.:	Page	1
Page title:		Drawing no.:		Page rev.:	Previous page:	
Filename:	FM2021V1.X.X	Constructor (project/page)	ATK	Last printed:	16.08.2022	Next page:
Page ref.:		Apr. (date/sign.)		Last correction:	16.08.2022	Number of pages:
						12

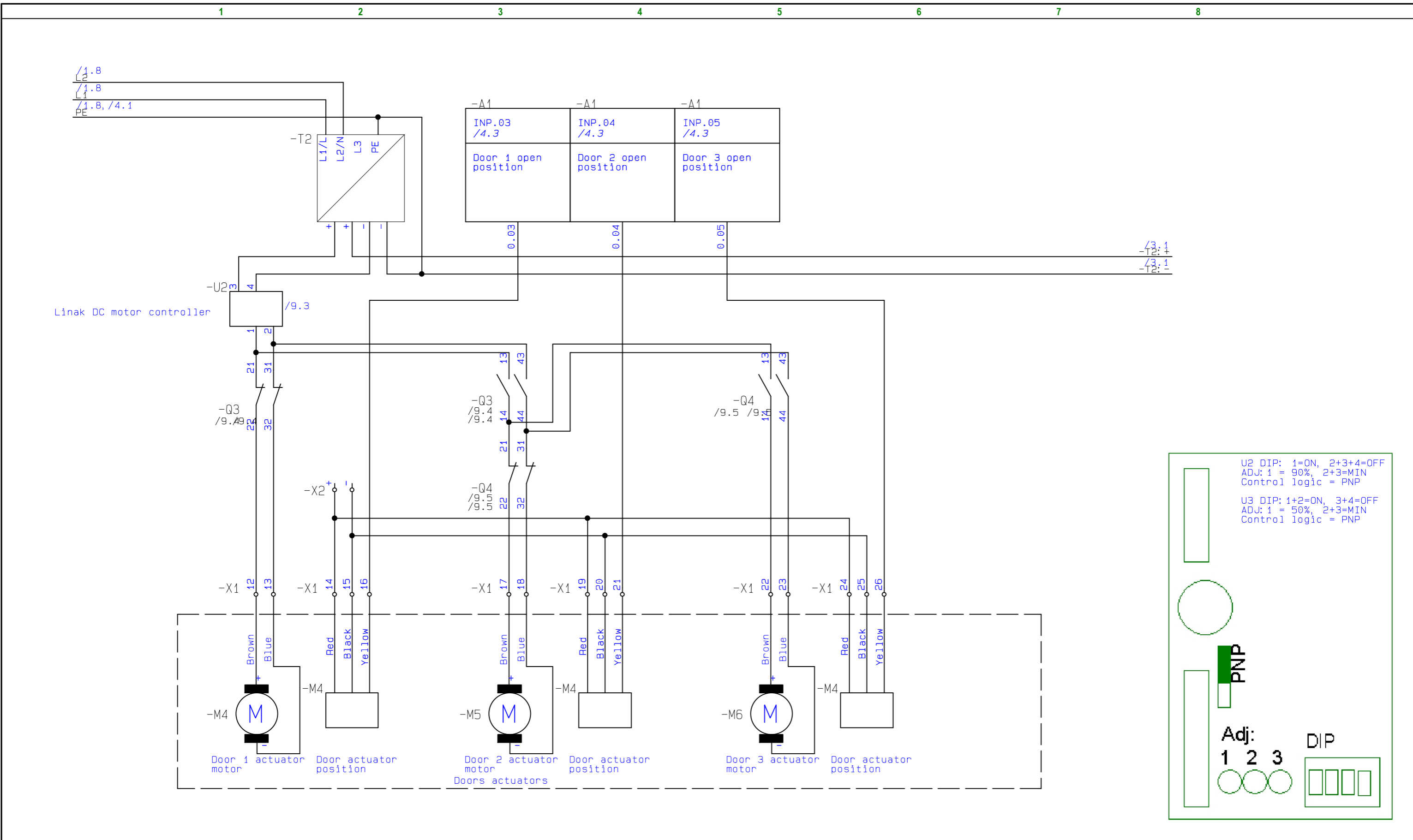

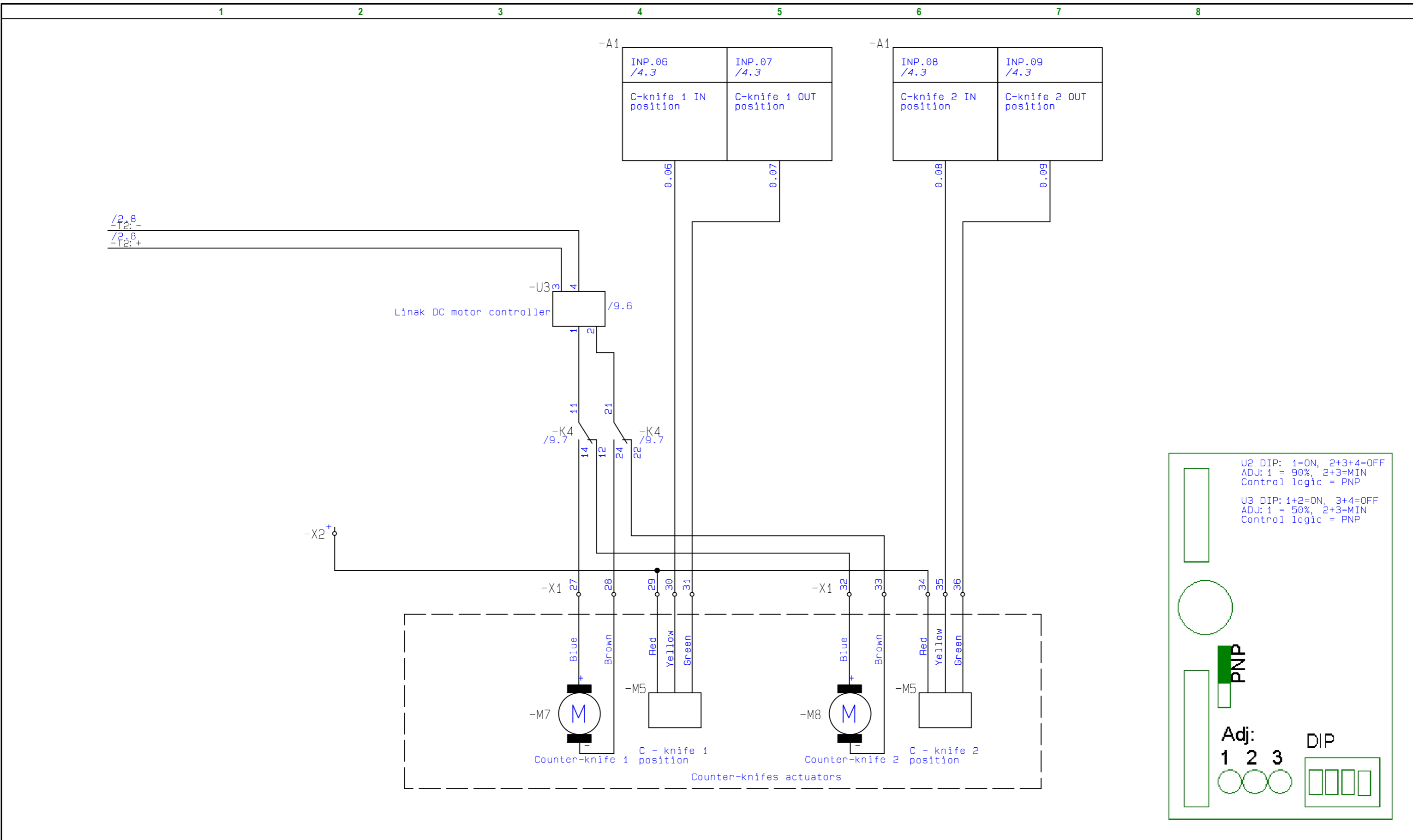

U2 DIP: 1=ON, 2+3+4=OFF
 ADJ: 1 = 90%, 2+3=MIN
 Control logic = PNP

U3 DIP: 1+2=ON, 3+4=OFF
 ADJ: 1 = 50%, 2+3=MIN
 Control logic = PNP

PNP

Adj:
 1 2 3

DIP

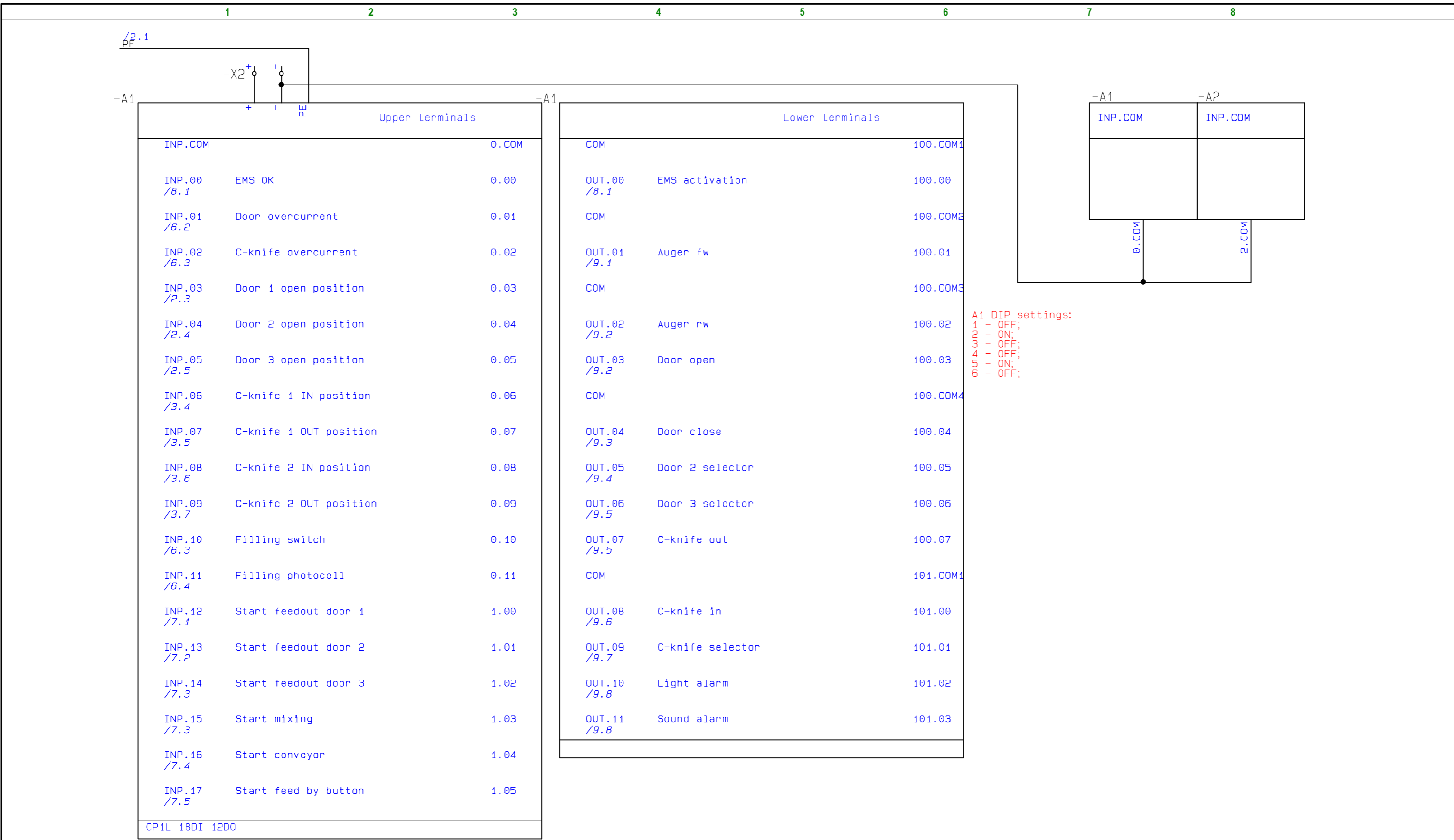

1

2

3

4

5

6

7

8

-A2

Upper terminals inputs		
INP.COM		2.COM
INP.18	Stop feed by button	2.00
INP.19	External alarm	2.01
INP.20	Conveyor belt 1 counter	2.02
INP.21	Conveyor belt 2 counter	2.03
INP.22		2.04
INP.23		2.05
INP.24		2.06
INP.25		2.07
INP.26		2.08
INP.27		2.09
INP.28		2.10
INP.29		2.11

-A2

Upper terminals		
COM		COM1
OUT.12	Conveyor belt 1	102.00 /10.2
COM		COM2
OUT.13	Conveyor belt 2	102.01 /10.3
COM		COM3
OUT.14	Filling source 1	102.02
OUT.15	Filling source 2	102.03 /10.5
COM		COM4
OUT.16	Filling source 3	102.04 /10.5
OUT.17	Filling source 4	102.05 /10.6
OUT.18	Filling source 5	102.06 /10.7
OUT.19	Filling source 6	102.07 /10.8

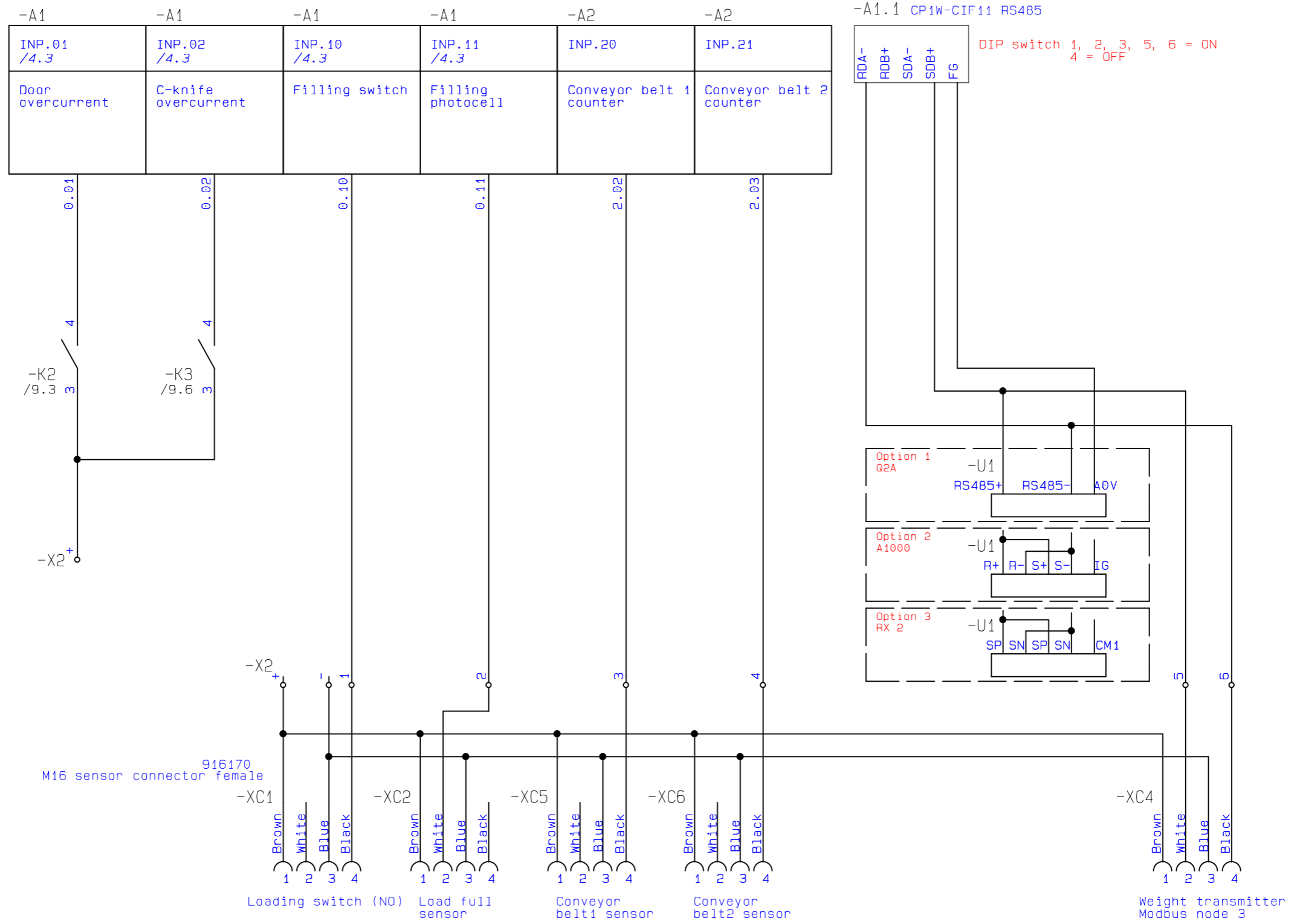

-A1	-A1	-A1	-A1	-A1	-A1	-A2	-A2
INP.12 /4.3	INP.13 /4.3	INP.14 /4.3	INP.15 /4.3	INP.16 /4.3	INP.17 /4.3	INP.18	INP.19
Start feedout door 1	Start feedout door 2	Start feedout door 3	Start mixing	Start conveyor	Start feed by button	Stop feed by button	External alarm

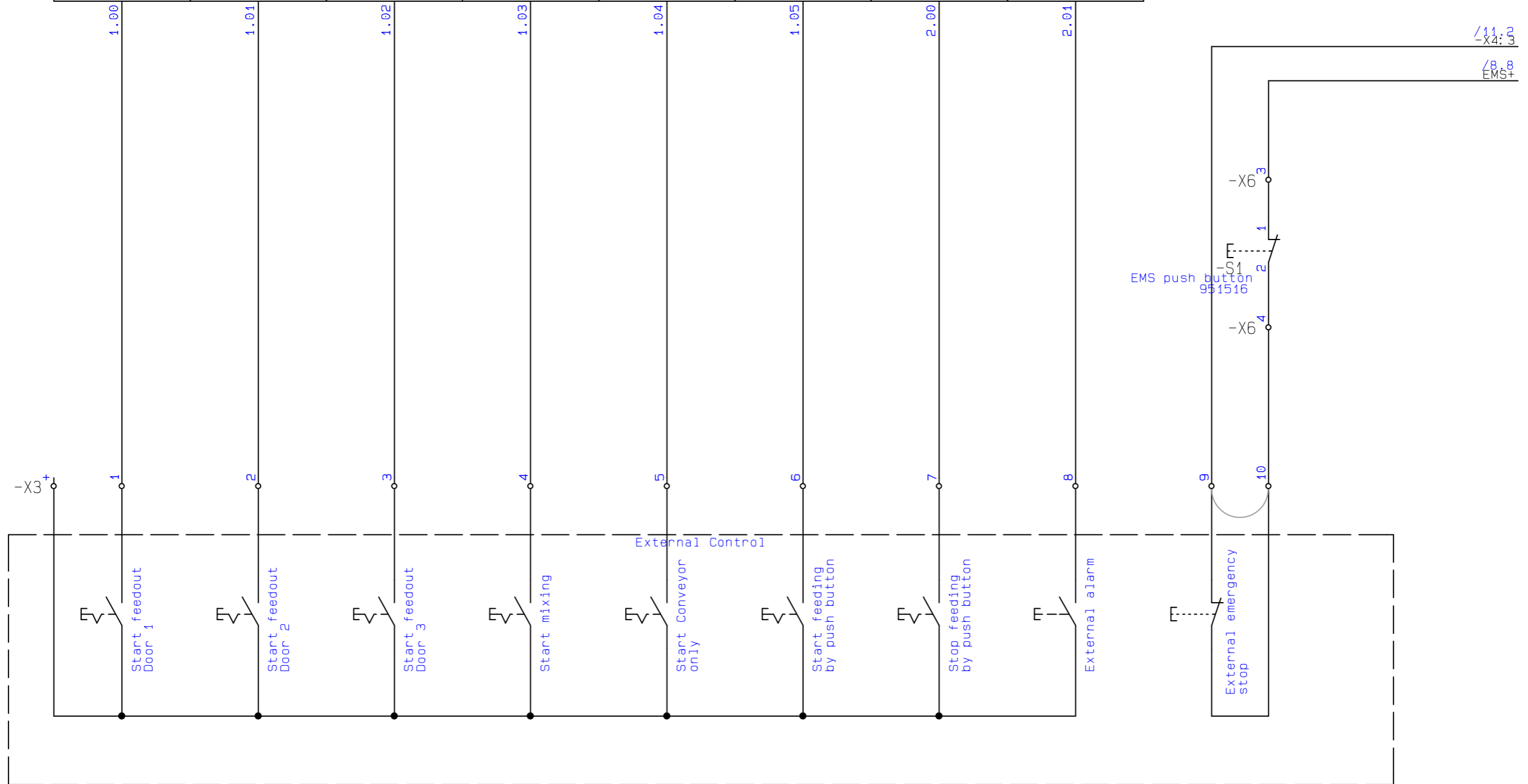

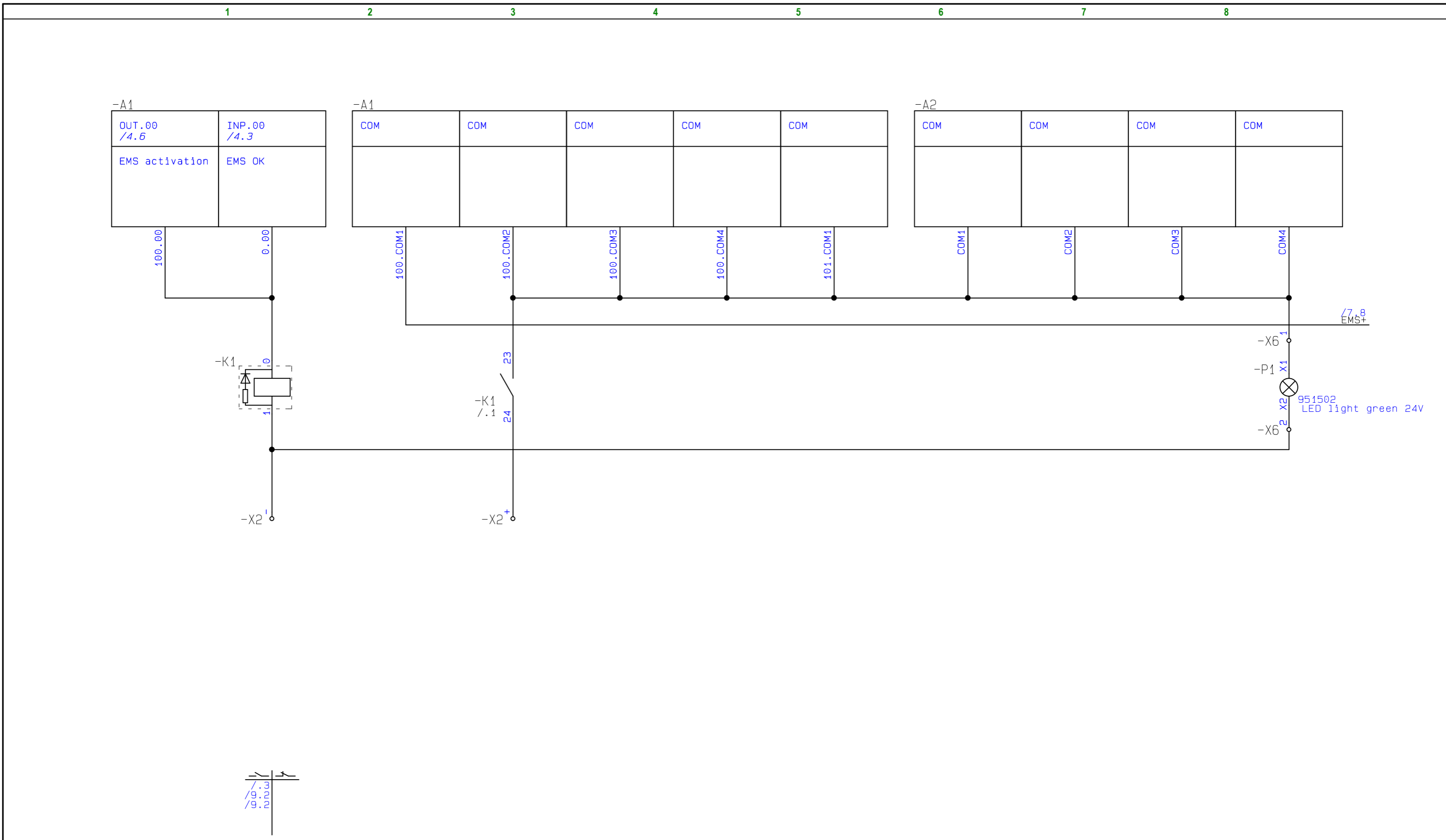

-A1

OUT.01 /4.6	OUT.02 /4.6	OUT.03 /4.6	OUT.04 /4.6	OUT.05 /4.6	OUT.06 /4.6	OUT.07 /4.6	OUT.08 /4.6	OUT.09 /4.6	OUT.10 /4.6	OUT.11 /4.6
Auger fw	Auger rw	Door open	Door close	Door 2 selector	Door 3 selector	C-knife out	C-knife in	C-knife selector	Light alarm	Sound alarm

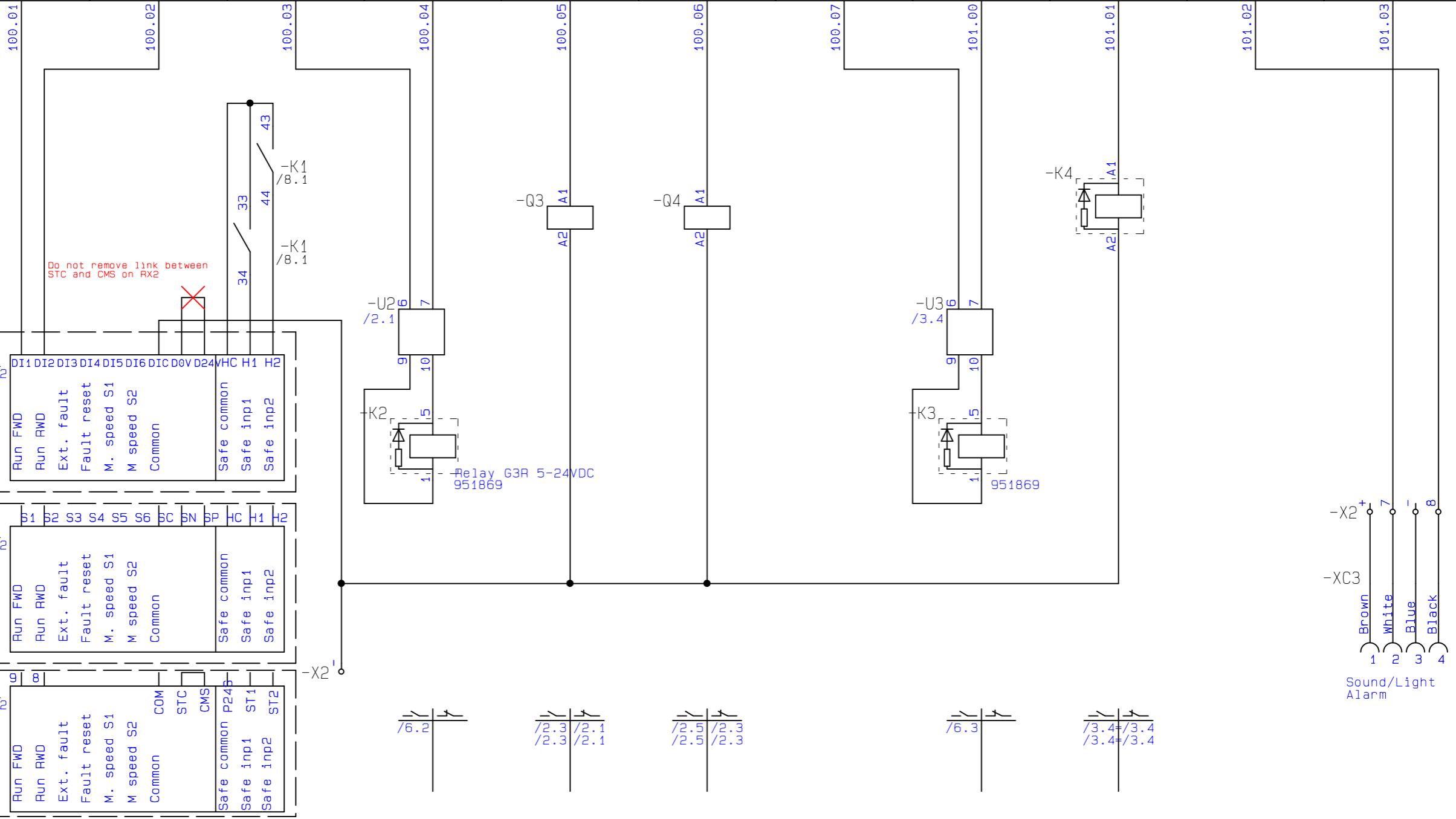

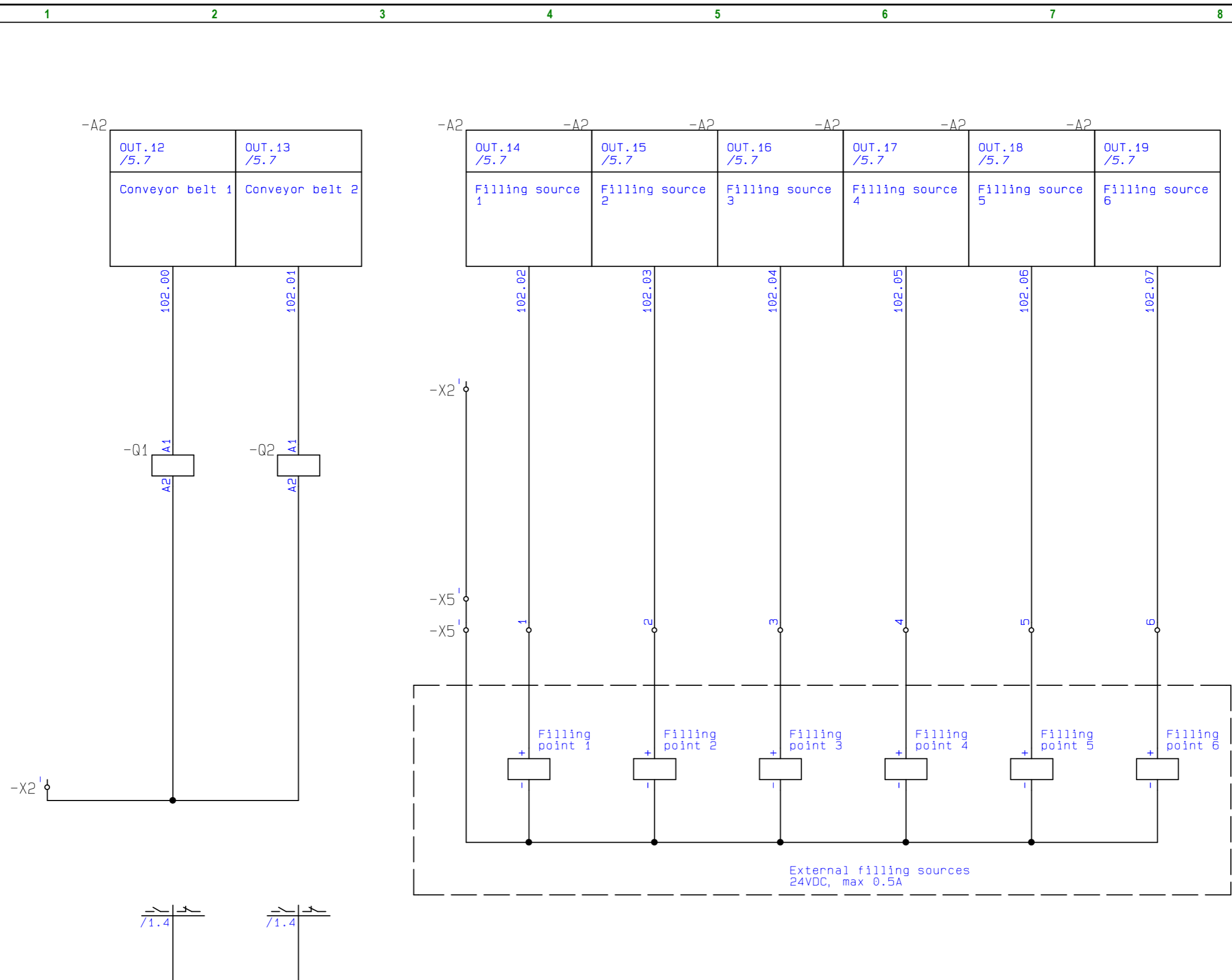

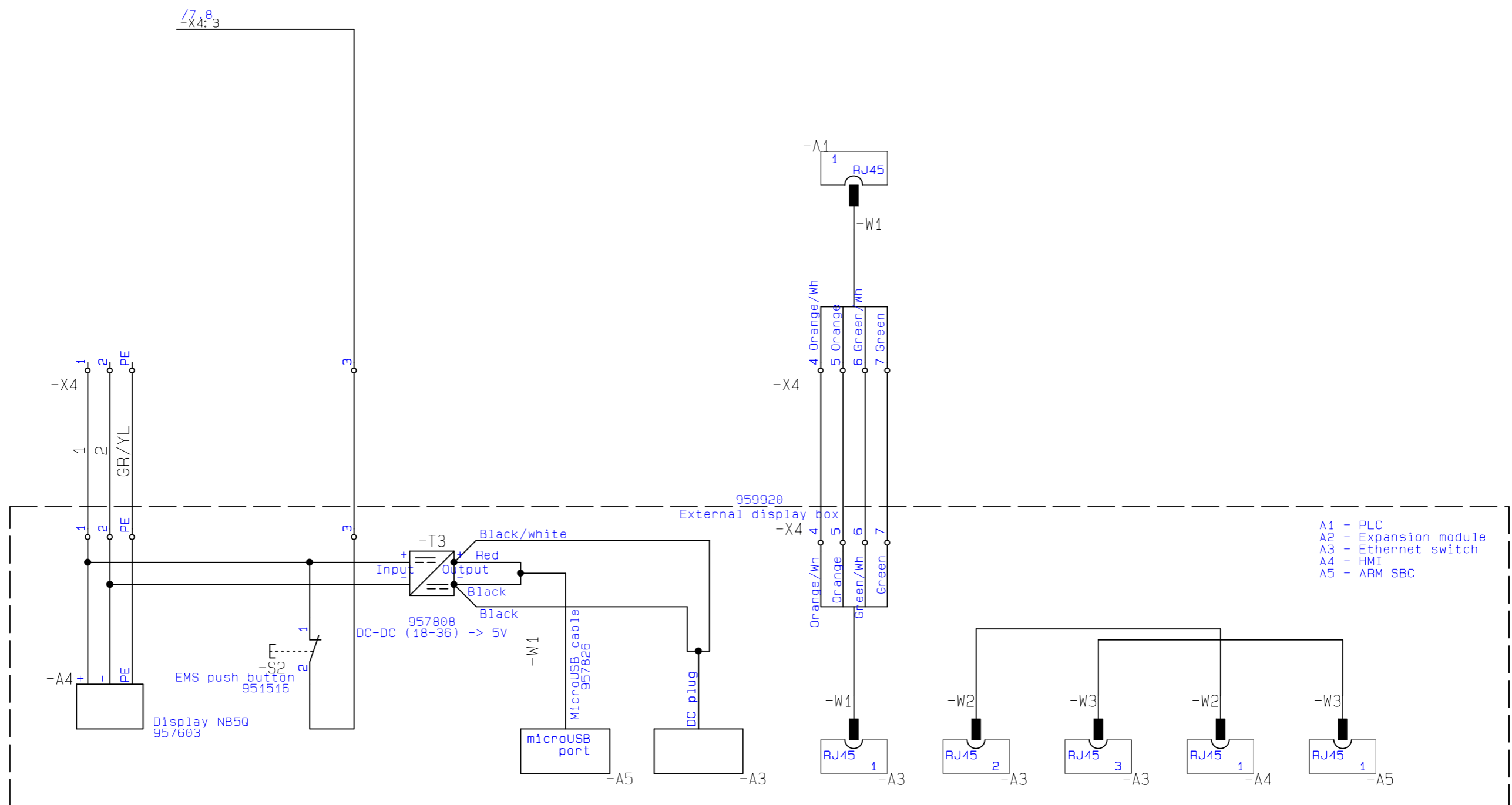

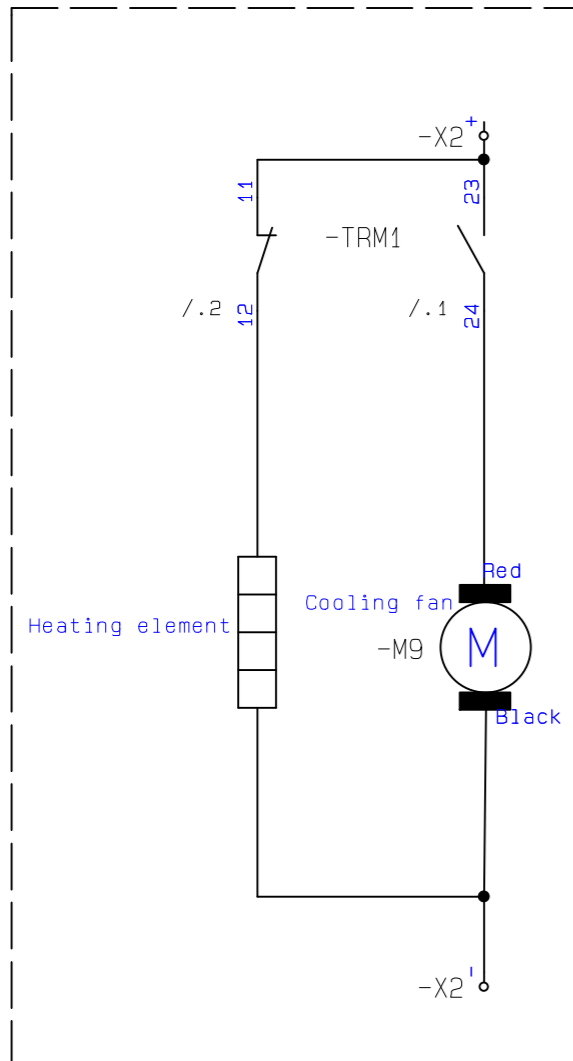

Cooling fan is optional

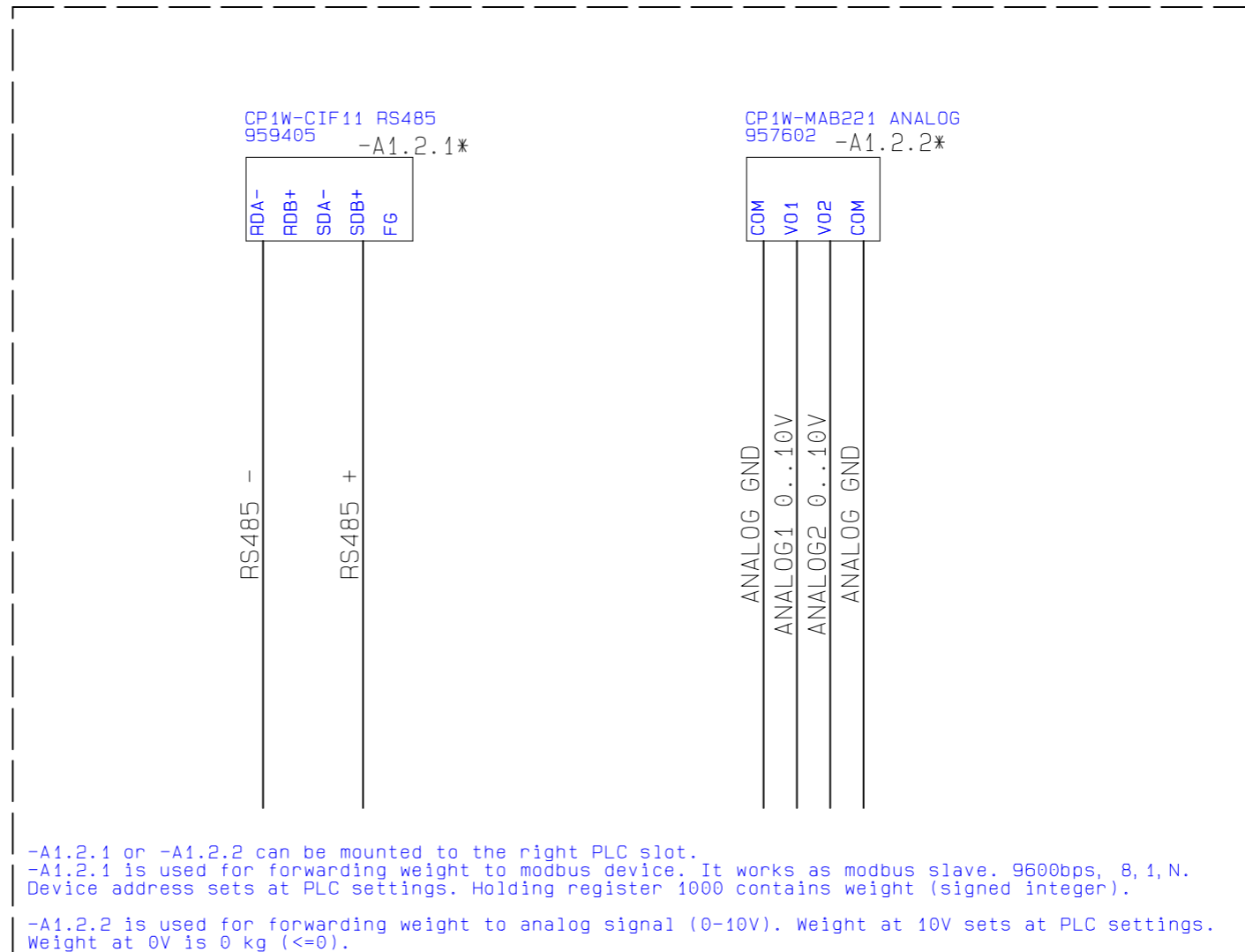

Optional weight forward